



CCIC Southern Electronic Product Testing (Shenzhen) Co., Ltd

CERTIFICATE OF EMC

CERTIFICATE NO.: SET2015-01426

Product: Car expansion board
Model: BL2000-CEB-V* (*=2-2.99, indicate the different customer or/and Software function number)
Applicant: ShenYang Bluelight Automatic Technology Co., Ltd.
Address: No. 37 Shiji Road, Hunnan New District, Shenyang, China

This is to certify that, on the basis of the tests undertaken as per Report No. SET2015-01426, the submitted sample of the above item complies with:

EN61000-6-4:2007+A1:2011
EN61000-6-2:2005

and fulfils testing requirement of the EMC directive 2004/108/EC

Signed for and on behalf of
CCIC Southern Electronic Product Testing (Shenzhen) Co., Ltd.



Wu Li An

Wu Li An, Vice Director

Date of Issue: Feb. 06, 2015



CCIC Southern Electronic Product Testing (Shenzhen) Co., Ltd.
 Building 28/29, Shiguo Industrial Area, Street, Nanshan District,
 Shenzhen, Guangdong, China
 Tel:86-755-26627338 Fax:86-755-26627238 <http://www.ccic-set.com>



EMC TEST REPORT

Report No.: SET2015-01426

Product: Car expansion board

Model No: BL2000-CEB-V* (*=2-2.99, indicate the different customer or/and Software function number)

Applicant: ShenYang Bluelight Automatic Technology Co., Ltd.

Address: No. 37 Shiji Road, Hunnan New District, Shenyang, China

Issued by: CCIC Southern Electronic Product Testing (Shenzhen)CO., Ltd.

Lab location: Building 28/29, Shigudong, Xili Industrial Area, Xili Street, Nanshan District, Shenzhen, Guangdong, China

Tel: 86 755 26627338 **Fax:** 86 755 26627238

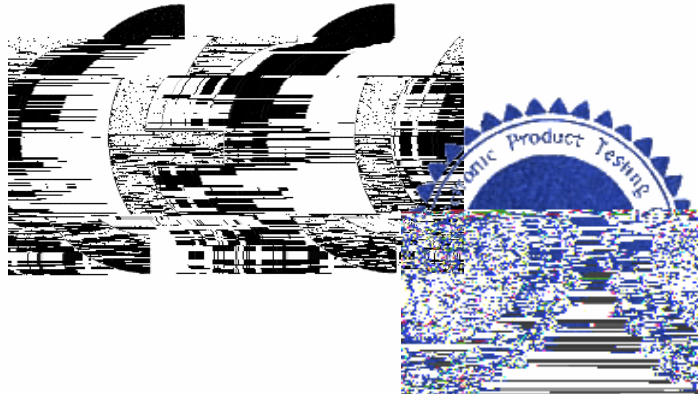

This test report consists of 23 pages in total. It may be duplicated completely for legal use with the approval of the applicant. It should not be reproduced except in full, without the written approval of our laboratory. The client should not use it to claim product endorsement by CCIC-SET. The test results in the report only apply to the tested sample. The test report shall be invalid without all the signatures of testing engineers, reviewer and approver. Any objections must be raised to CCIC-SET within 15 days since the date when the report is received. It will not be taken into consideration beyond this limit.

查询码: 6PA7ZR5b



Report

Product.....: Car expansion board
Model No.: BL2000-CEB-V* (*=2-2.99, indicate the different customer or/and Software function number)
Brand Name.....: /
Applicant.....: ShenYang Bluelight Automatic Technology Co., Ltd.
Applicant Address.....: No. 37 Shiji Road, Hunnan New District, Shenyang, China
Manufacturer.....: ShenYang Bluelight Automatic Technology Co., Ltd.
Manufacturer Address.....: No. 37 Shiji Road, Hunnan New District, Shenyang, China
Test Standards.....: **EN61000-6-4:2007+A1:2011** Electromagnetic compatibility (EMC) -- Part 6-4: Generic standards - Emission standard for industrial environments
EN61000-6-2:2005 Electromagnetic compatibility (EMC) -- Part 6-2: Generic standards - Immunity for industrial environments
Test Result.....: Pass
Tested by: Chen Weichang Feb. 06. 2015
Signature, Date
Reviewed by.....: Zhu Qi Feb. 06. 2015
Signature, Date
Approved by.....: Wu Lian Feb. 06. 2015
Signature, Date





Table of Contents

Report.....	2
1 General Information.....	5
1.1 Description of EUT.....	5
1.2 Objective.....	5
2 Test Facilities and Configuration.....	5
2.1 Environmental Conditions.....	5
2.2 Measurement Uncertainty.....	5
2.3 Test Standards and Results.....	5
2.4 List of Equipments Used.....	7
3 Emission Test.....	8
3.1 EUT Setup and Operating Conditions.....	8
3.2 Radiated Disturbance Measurement.....	8
3.2.1 Limits of Radiated Disturbance.....	8
3.2.2 Test Setup.....	8
3.2.3 Test Result.....	9
4 Immunity Test.....	11
4.1 EUT Setup and Operating Conditions.....	11
4.2 Performance Criteria.....	11
4.3 Electrostatic Discharge Immunity Test.....	11
4.3.1 Test Specification.....	11
4.3.2 Test Setup.....	12
4.3.3 Test Result.....	12
4.4 Radiated, Radio Frequency Electromagnetic Field Immunity Test.....	13
4.4.1 Test Specification.....	13
4.4.2 Test Setup.....	13
4.4.3 Test Result.....	14



4.5 Electrical Fast Transient/Burst Immunity Test.....	14
4.5.1 Test Specification	14
4.5.2 Test Setup	14
4.5.3 Test Result	15
4.6 Surge Immunity Test	15
4.6.1 Test Specification	15
4.6.2 Test Setup	15
4.6.3 Test Result	15
4.7 Immunity to Conducted Disturbances Induced by RF Fields	15
4.7.1 Test Specification	16
4.7.2 Test Setup	16
4.7.3 Test Result	16
4.8 Power Frequency Magnetic Field Immunity Test	17
4.8.1 Test Specification	17
4.8.2 Test Setup	17
4.8.3 Test Result	17
Appendix I: Photographs of the EUT.....	18
Appendix II: Photographs of EMC Test Configuration	19

1 General Information

1.1 Description of EUT

Product: Car expansion board
Model No.: BL2000-CEB-V2.0
Brand Name: /
Serial No.: /
Rating: Input: 24V DC
Accessories: /

NOTE:

1. For more detailed features description about the EUT, please refer to User's Manual.
2. Application model is BL2000-CEB-V* (*=2-2.99, indicate the different customer or/another software function number). Models differences do not affect the performance of EMC. All tests were performed on Model BL2000-CEB-V2.0 and results represented other models.
3. The highest frequency of the internal source of the EUT is below 108 MHz, so the radiated emission measurement shall be made up to 1GHz.

1.2 Objective

Perform ElectroMagnetic Interference (EMI) and ElectroMagnetic Susceptibility (EMS) tests for CE Marking.

2 Test Facilities and Configuration

2.1 Environmental Conditions

During the measurement the environmental conditions were within the listed ranges:

- Temperature: 15-35°C
- Humidity: 30-60 %
- Atmospheric pressure: 86-106 kPa

2.2 Measurement Uncertainty

The uncertainty is calculated using the methods suggested in the "Guide to the Expression of Uncertainty in Measurement" (GUM) published by ISO.



2.3 Test Standards and Results

The EUT has been tested according to the following specifications:

EMISSION		
Standard	Test Type	Result
EN61000-6-4:2007+A1:2011	Radiated disturbance	PASS
IMMUNITY (EN61000-6-2:2005)		
Basic Standard	Test Type	Result
IEC 61000-4-2	Electrostatic discharge immunity	PASS
IEC 61000-4-3	Radiated, radio frequency electromagnetic field immunity	PASS
IEC 61000-4-4	Electrical fast transient/burst immunity	PASS
IEC 61000-4-5	Surge immunity	PASS
IEC 61000-4-6	Immunity to conducted disturbances induced by RF fields	PASS
IEC 61000-4-8	Power frequency magnetic field immunity	PASS



2.4 List of Equipments Used

Description	Manufacturer	Model No.	Calibration Date	Serial No.
Test Receiver	ROHDE&SCHWARZ	ESCI	Jun.10, 2015	A0902601
Broadband Ant.	ROHDE&SCHWARZ	VULB 09160	Jun.10, 2015	A0805560
Anechoic Chamber	Albatross	SAC-10MAC 19.6*11.8*8.55m	Jun.23, 2015	A0802520
Signal Generator	ROHDE&SCHWARZ	SMR27	Jun.10, 2015	A0304219
Signal Generator	ROHDE&SCHWARZ	SML02	Jun.10, 2015	A0304261
EMS Antenna	Amplifier Research	AR AT1080	Jun.10, 2015	A0304249
EMS Antenna	Amplifier Research	AR AT4002A	Jun.10, 2015	A0304250
Power Amplifier	Amplifier Research	150W1000	/	A0304247
Power Amplifier	Amplifier Research	AR 75A250M	/	A0304255
Power Amplifier	Amplifier Research	25S1g4AM1	/	A0304248
Capacitive clamp	ROHDE&SCHWARZ	F2301	/	A0304258
EFT Test System	HAEFELY	PEFT JUNIOR	May.22, 2015	A0103110
Surge Test System	EM TEST	VCS500M10	Jun.10, 2015	A0712509
	EM TEST	CNV503S9	Jun.10, 2015	A0712510
ESD Test System	EM TEST	ESD30C	Sep.24.2015	A0712513
Magnetic Field Tester	HAEFELY	MAG 100.1	Jun.10. 2015	A0103109

NOTE: Equipments above have been calibrated and are in the period of validation.

3 Emission Test

3.1 EUT Setup and Operating Conditions

The EUT was powered by 24V DC mains. The EUT was continuously operated during the test.

3.2 Radiated Disturbance Measurement

3.2.1 Limits of Radiated Disturbance

Frequency range (MHz)	Quasi peak limits(dB μ V/m), at 10m measurement distance
30 – 230	40
230 - 1000	47

Notes:

- (1) The lower limit shall apply at the transition frequency.
- (2) Additional provisions may be required for cases where interference occurs.

3.2.2 Test Setup

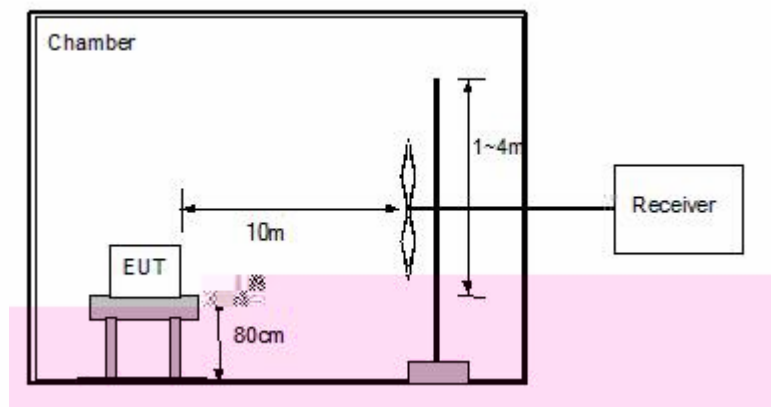



3.2.3 Test Result

No.	Frequency (MHz)	Antenna Polarization	Antenna Height (cm)	Table Angle (Degree)	QP Limits (dB μ V/m)	Emission Level (dB μ V/m)
1	52.080000	H	400	0	40	24.8
2	64.000000	H	400	0	40	27.8
3	127.960000	H	400	0	40	29.1
4	160.000000	H	400	0	40	34.8
5	224.000000	H	400	0	40	31.6
6	390.120000	H	400	0	40	24.2
7	31.960000	V	100	0	40	21.2
8	52.080000	V	100	0	40	27.4
9	75.840000	V	100	0	40	21.1
10	160.000000	V	100	0	40	21.3
11	224.000000	V	100	0	40	28.3
12	320.000000	V	100	0	40	29.1

1. Electromagnetic radiation disturbances, max peak detector, antenna polarization: Vertical

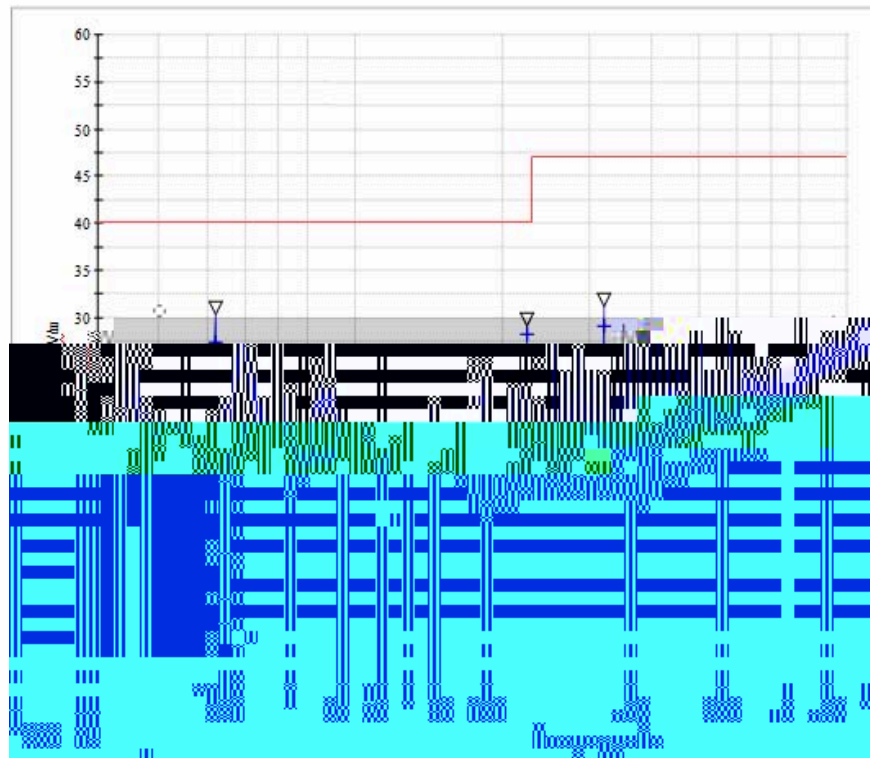

2. Electromagnetic radiation disturbances, max peak detector, antenna polarization: Horizontal

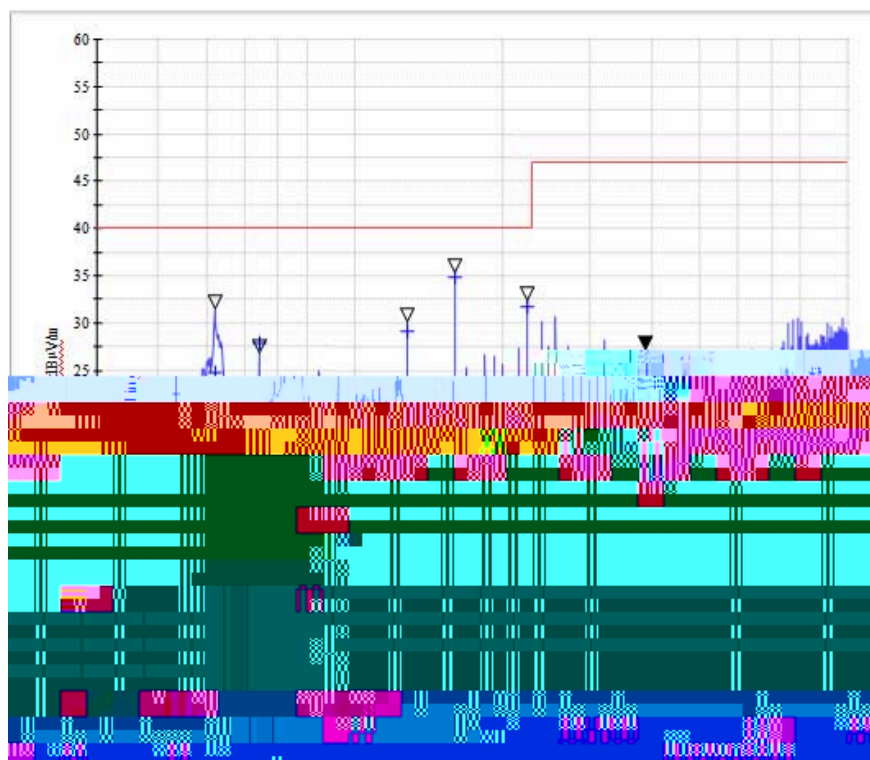

4 Immunity Test

4.1 EUT Setup and Operating Conditions

Same as 3.1.

4.2 Performance Criteria

Criterion A	The apparatus shall continue to operate as intended. No degradation of performance or loss of function is allowed below a performance level specified by the manufacturer, when the apparatus is used as intended.
Criterion B	The apparatus shall continue to operate as intended after the test. No degradation of performance or loss of function is allowed below a performance level specified by the manufacturer, when the apparatus is used as intended.
Criterion C	Temporary loss of function is allowed, provided the function is self-recoverable or can be restored by the operation of the controls.

4.3 Electrostatic Discharge Immunity Test

4.3.1 Test Specification

Basic Standard:	IEC 61000-4-2
Discharge Impedance	330 Ω / 150 pF
Discharge Voltage:	Air Discharge: 8 kV Contact Discharge: 4kV
Polarity:	Positive / Negative
Number of Discharge:	Minimum 20 times at each test point
Discharge Mode:	Single discharge
Discharge Period:	1-second minimum
Criterion:	B

4.3.2 Test Setup

EUT

For the actual test configuration, please refer to Appendix II: Photographs of the Test Configuration.

4.3.3 Test Result

Test Points	Discharge Level (kV)	Discharge Mode	Observation	Comply with Criterion
Screen	$\pm 2, 4, 6, 8$	Air	Note(1)	A
HCP	$\pm 2, 4$	Contact	Note(1)	A
VCP	$\pm 2, 4$	Contact	Note(1)	A

NOTE:

(1). The EUT continued to operate as intended. No degradation of performance was observed.

4.4 Radiated, Radio Frequency Electromagnetic Field Immunity Test

4.4.1 Test Specification

Basic Standard:	EN 61000-4-3		
Frequency Range:	80 MHz – 1000MHz	1.4GHz – 2.0GHz	2.0GHz – 2.7GHz
Field Strength:	10V/m	3V/m	1V/m
Modulation:	1kHz sine wave, 80%, AM modulation		
Frequency Step:	1% of fundamental		
Polarity of Antenna	Horizontal and Vertical		
Test Distance:	3m		
Antenna Height:	1.5m		
Dwell Time:	3 seconds		
Criterion:	A		

4.4.2 Test Setup

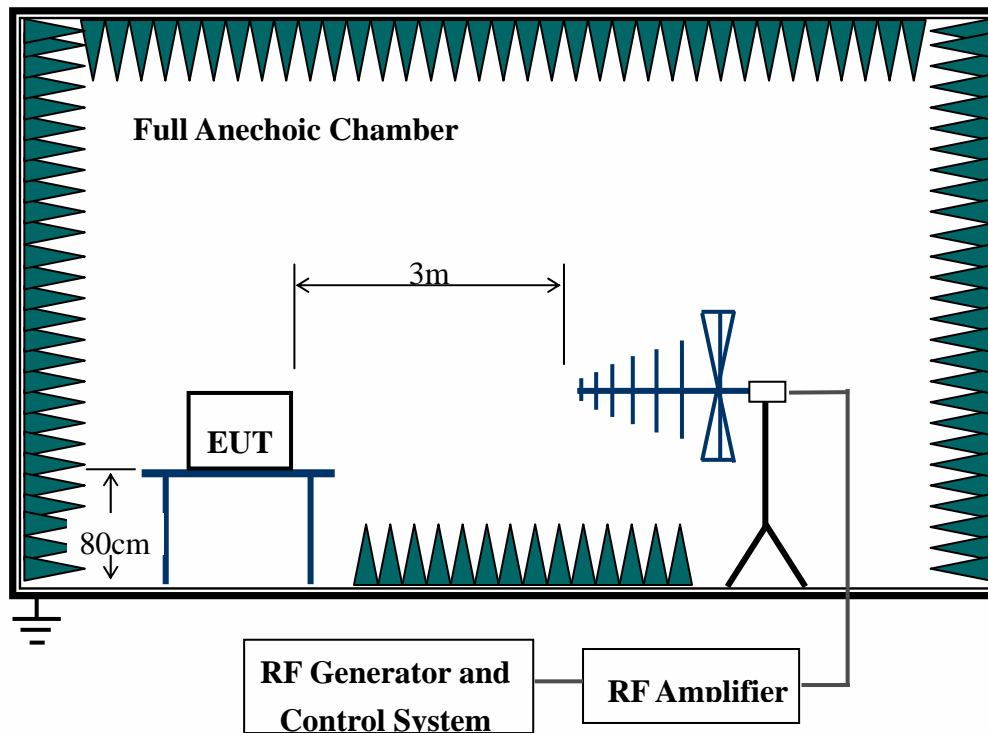

4.4.3 Test Result

Frequency	Polarity	Azimuth	Field Strength (V/m)	Observation	Comply with Criterion
80-1000 MHz	V&H	0,90, 80, 270	10	Note(1)	A
1.4-2.0GHz	V&H	0,90, 80, 270	3	Note(1)	A
2.0-2.7GHz	V&H	0,90, 80, 270	1	Note(1)	A

NOTE:

(1). The EUT continued to operate as intended. No degradation of performance was observed.

4.5 Electrical Fast Transient/Burst Immunity Test

4.5.1 Test Specification

Basic Standard: IEC 61000-4-4



For the actual test configuration, please refer to Appendix II: Photographs of the Test Configuration.

5.3 Test Result

Test Point	Polarity	Test Level (kV)	Observation	Comply with Criterion
DC. power	+/-	2	Note (1)	A

4.7 Immunity to Conducted Disturbances Induced by RF Fields

4.7.1 Test Specification

Basic Standard:	IEC 61000-4-6
Frequency Range:	0.15 MHz – 80 MHz
Field Strength:	10V
Modulation:	1 kHz Sine Wave, 80%, AM Modulation
Frequency Step:	1% of fundamental
Coupled Cable:	DC. power line
Coupling Device:	Capacitive clamp
Criterion:	A

4.7.2 Test Setup

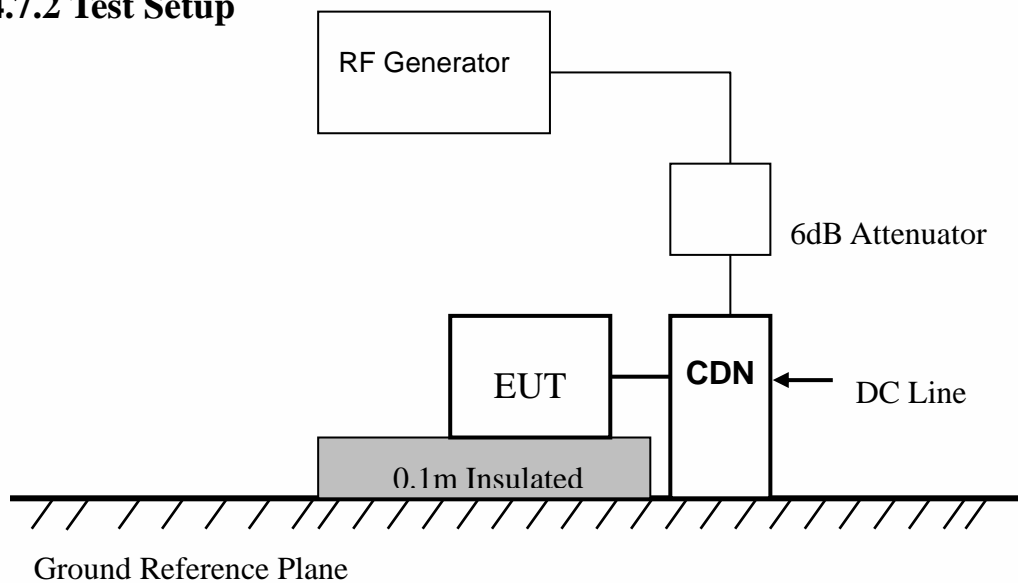

4.7.3 Test Result

Test Point	Frequency	Field Strength (Vrms)	Observation	Comply with criterion
DC Power Line	0.15 – 80 MHz	10	Note(1)	A

NOTE:

(1). The EUT continued to operate as intended. No degradation of performance was observed.



4.8 Power Frequency Magnetic Field Immunity Test

4.8.1 Test Specification

Basic Standard:	IEC 61000-4-8
Frequency Range:	50Hz

Appendix I: Photographs of the EUT

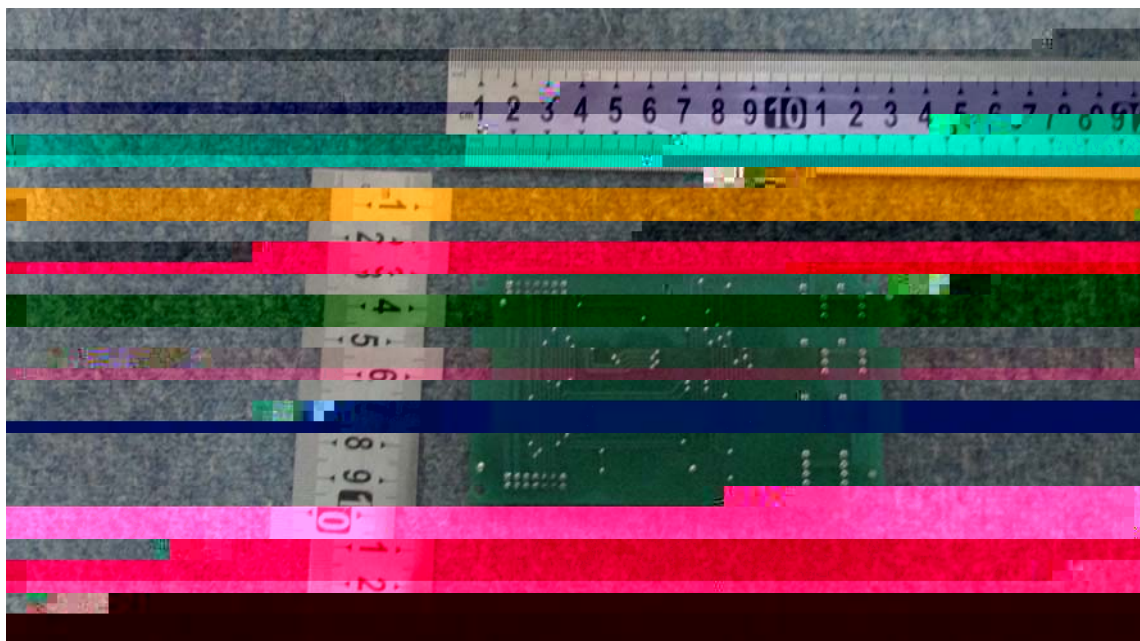

Appendix II: Photographs of EMC Test Configuration

1. Radiated Field Strength Measurement

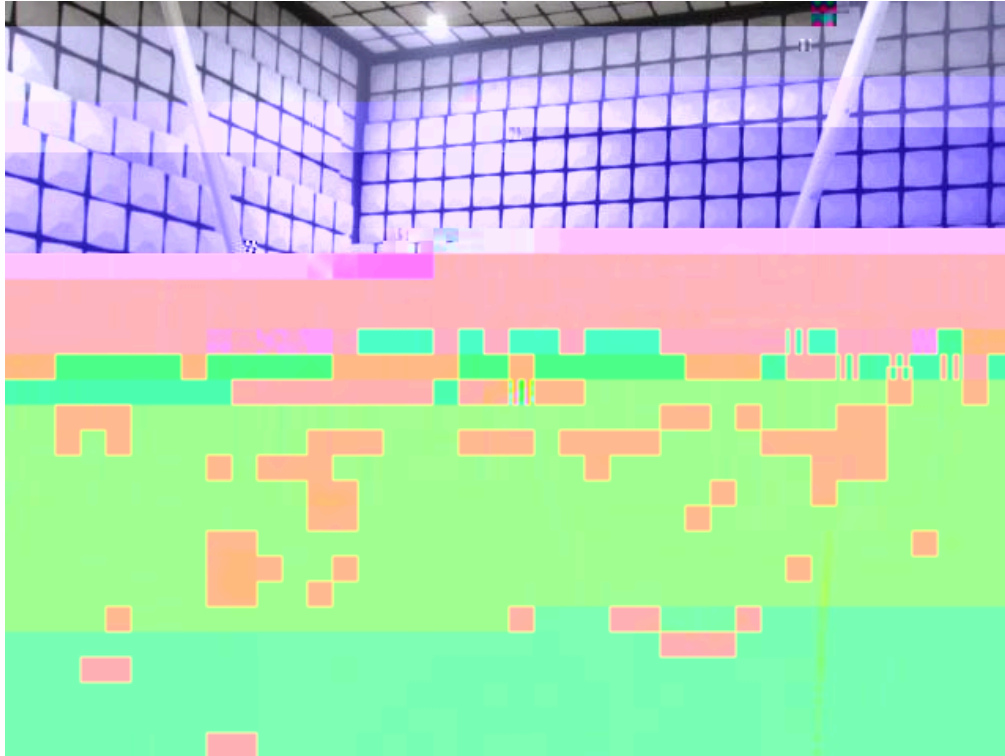

2. Electrostatic Discharge Immunity Test



3. Radiated, Radio Frequency Electromagnetic Field Immunity Test (below 1GHz)

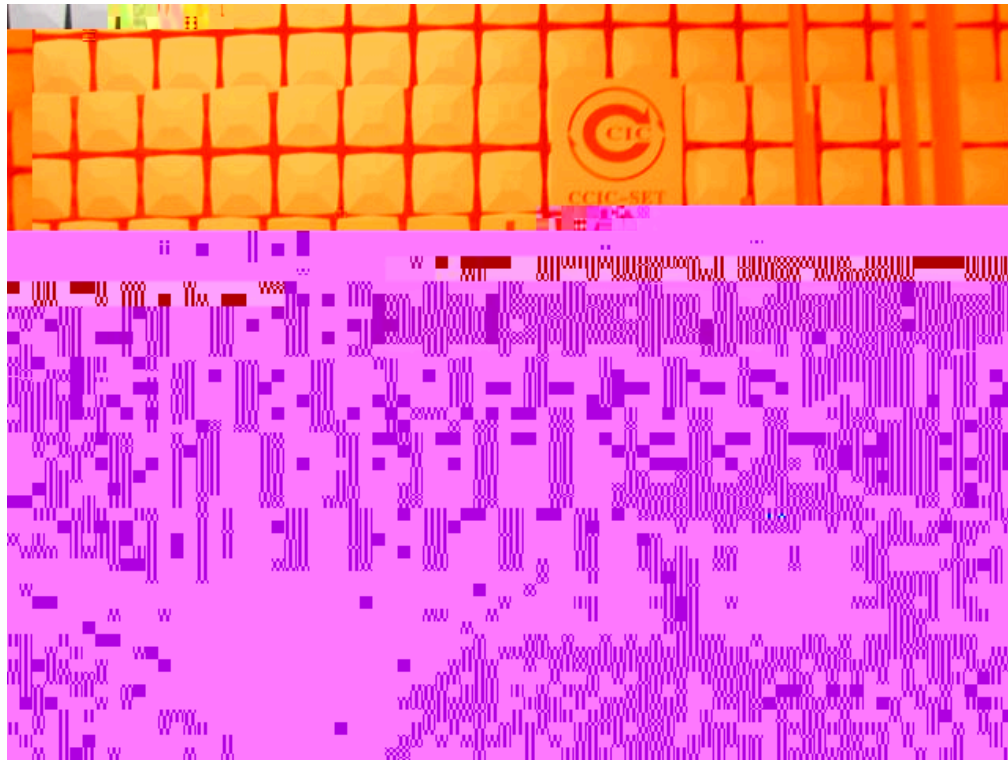

4. Radiated, Radio Frequency Electromagnetic Field Immunity Test (above 1GHz)

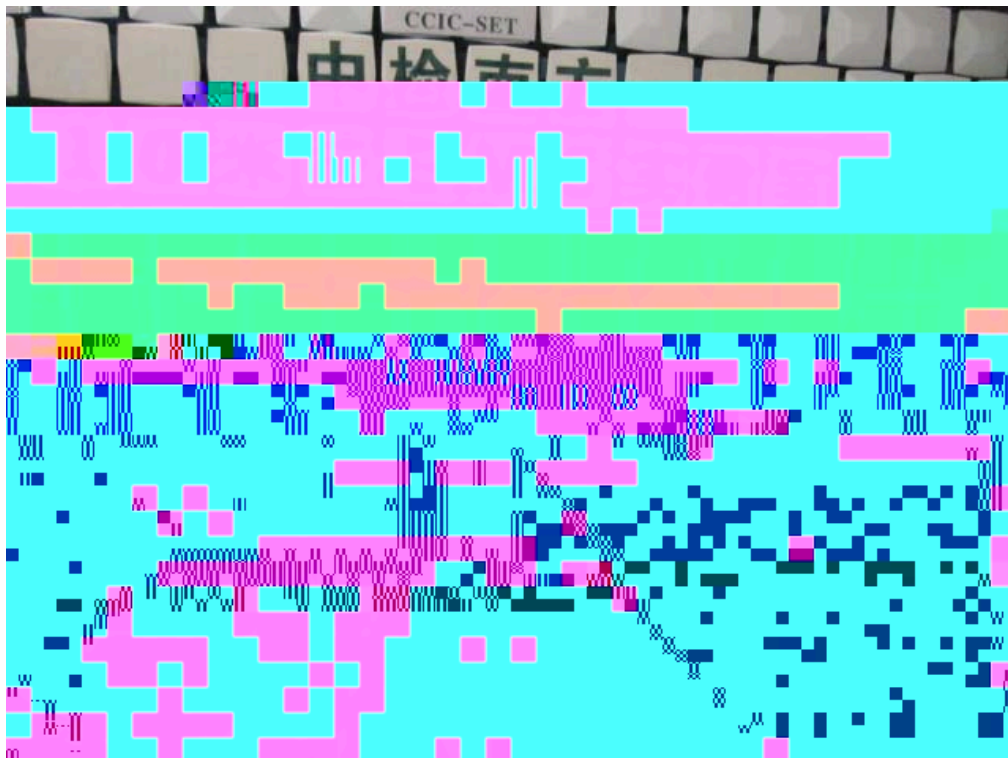

5. Electrical Fast Transient/Burst Immunity Test

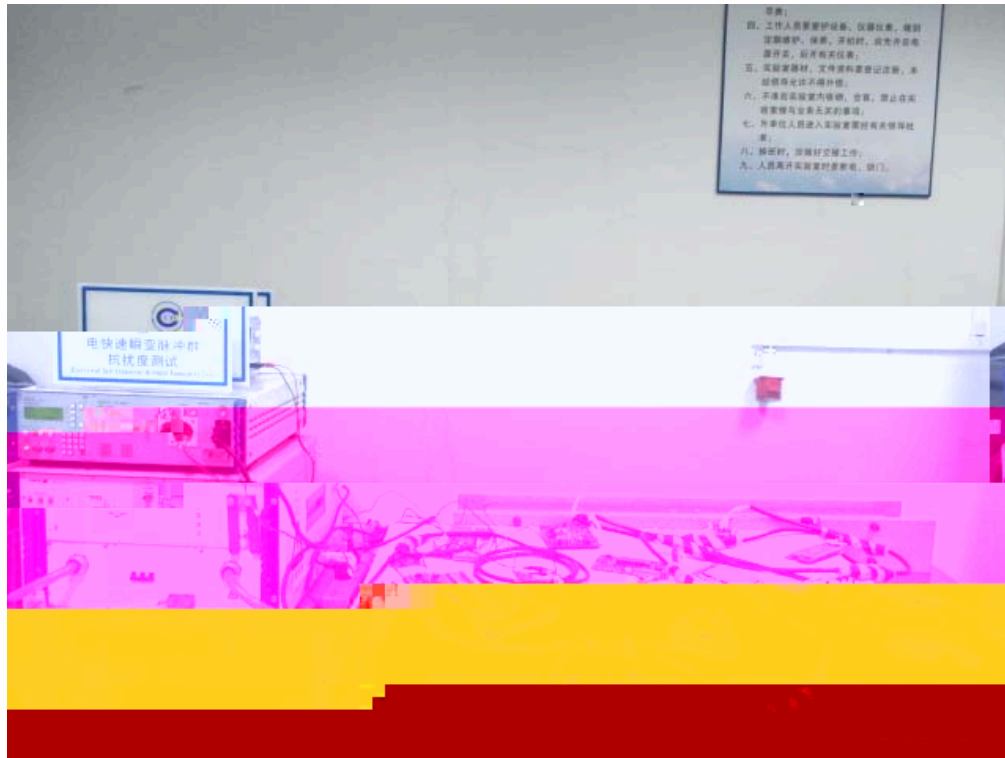

6. Surge Immunity Test

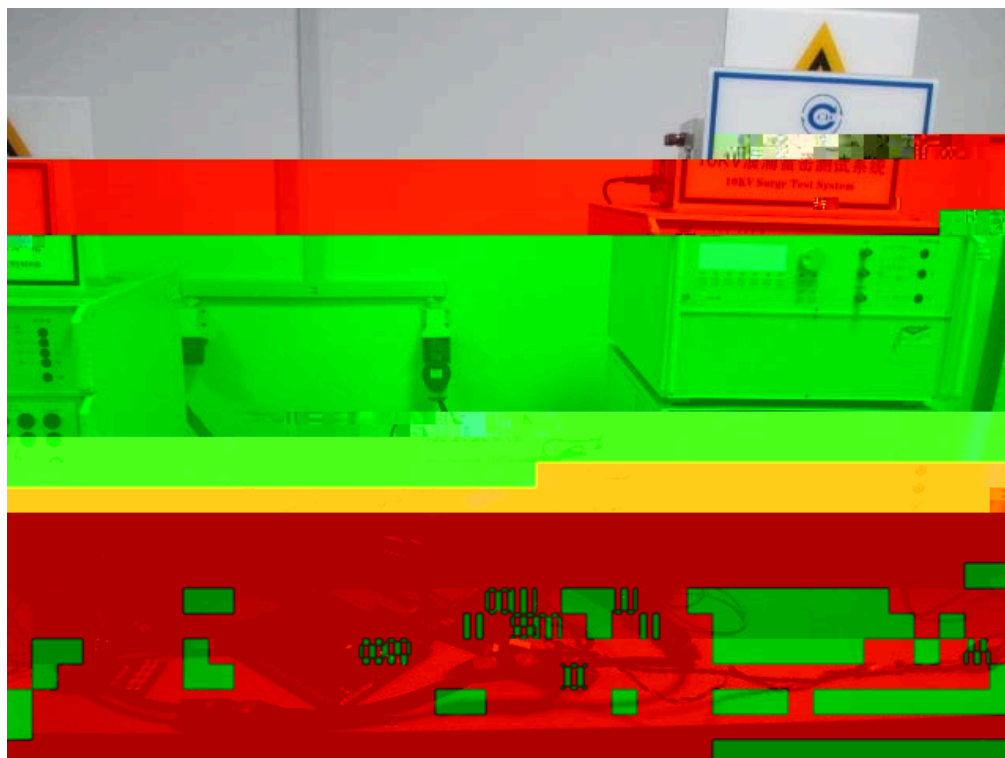

7. Immunity to Conducted Disturbances Induced by RF Fields

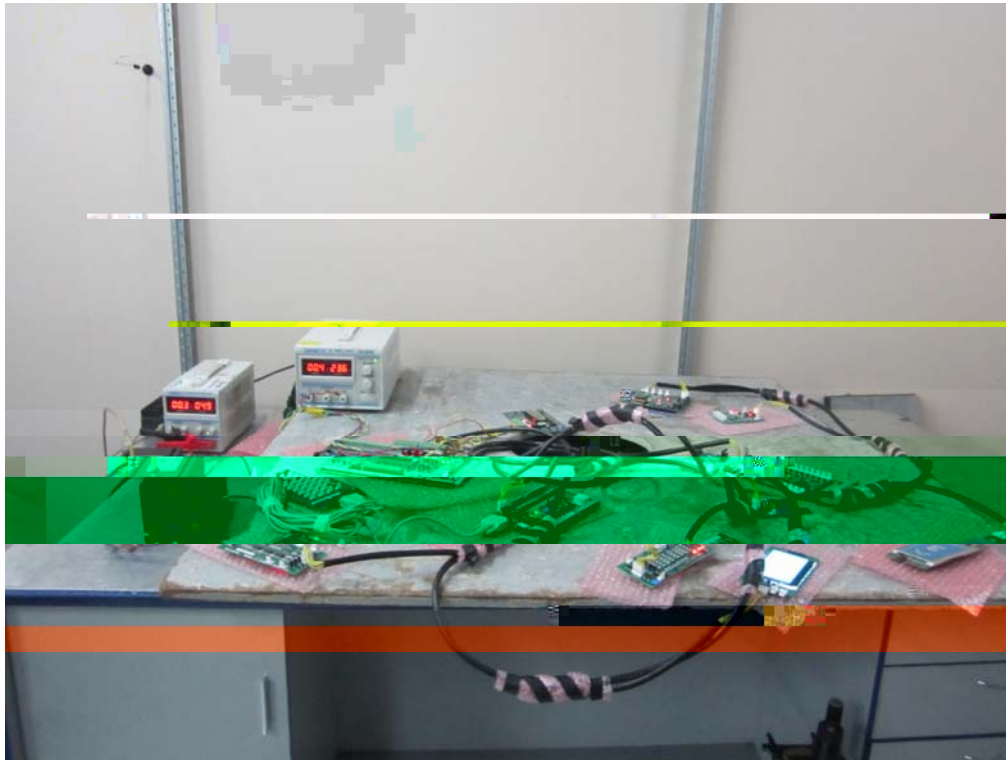

8. Power Frequency magnetic Field Immunity

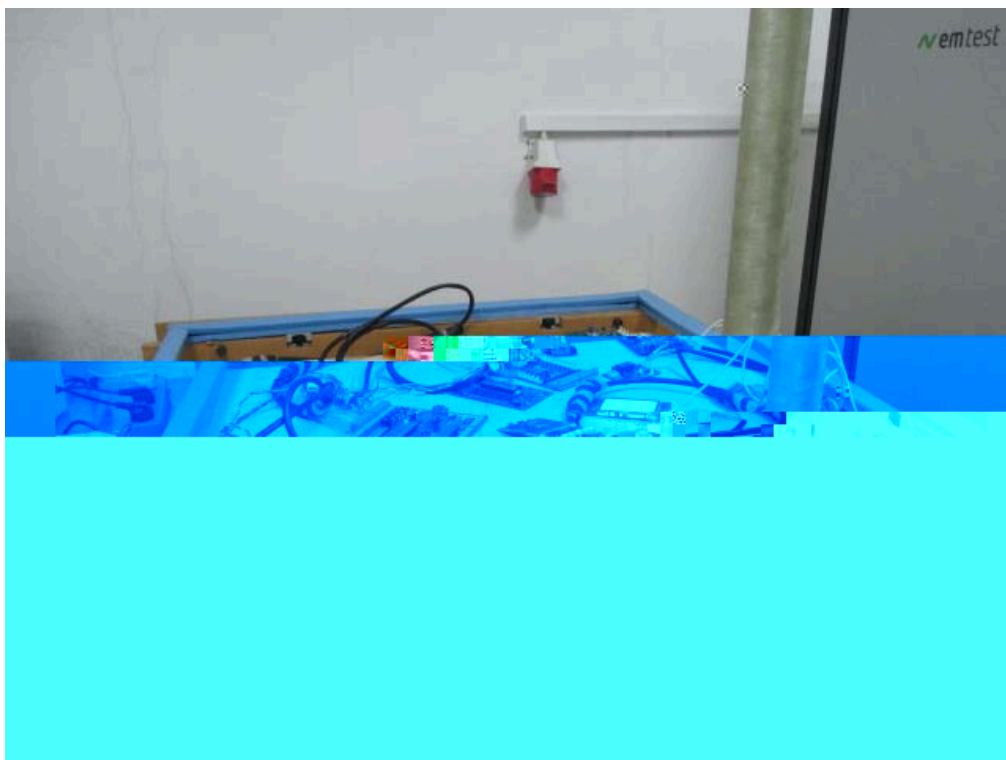



STATEMENT

1. **This test laboratory is accredited by CNAS, Accreditation Certificate No.L1659.**
2. **The test report is invalid without stamp of laboratory.**
3. **The test report is invalid without signature of person(s) testing and authorizing.**
4. **The test report is invalid if erased and corrected.**
5. **Test results of the rep8**